

Kymera 328i

Intelligent and Multi-modal Spectrograph
for Physical and Life Science

Key Specifications

- ✓ 328 mm focal length
- ✓ F/4.1 aperture
- ✓ Adaptive Focus (Patented)
- ✓ Dual inputs and outputs
- ✓ Quad grating turret & eXpressID™
- ✓ TruRes™ technology
- ✓ Plug-and-Play USB interface

Key Applications

- ✓ Raman & Luminescence/PL
- ✓ Absorption/Transmission
- ✓ SFG/SHG
- ✓ LIBS/OES
- ✓ Material Science
- ✓ Chemistry & Catalysis
- ✓ Life Science/Biomedical

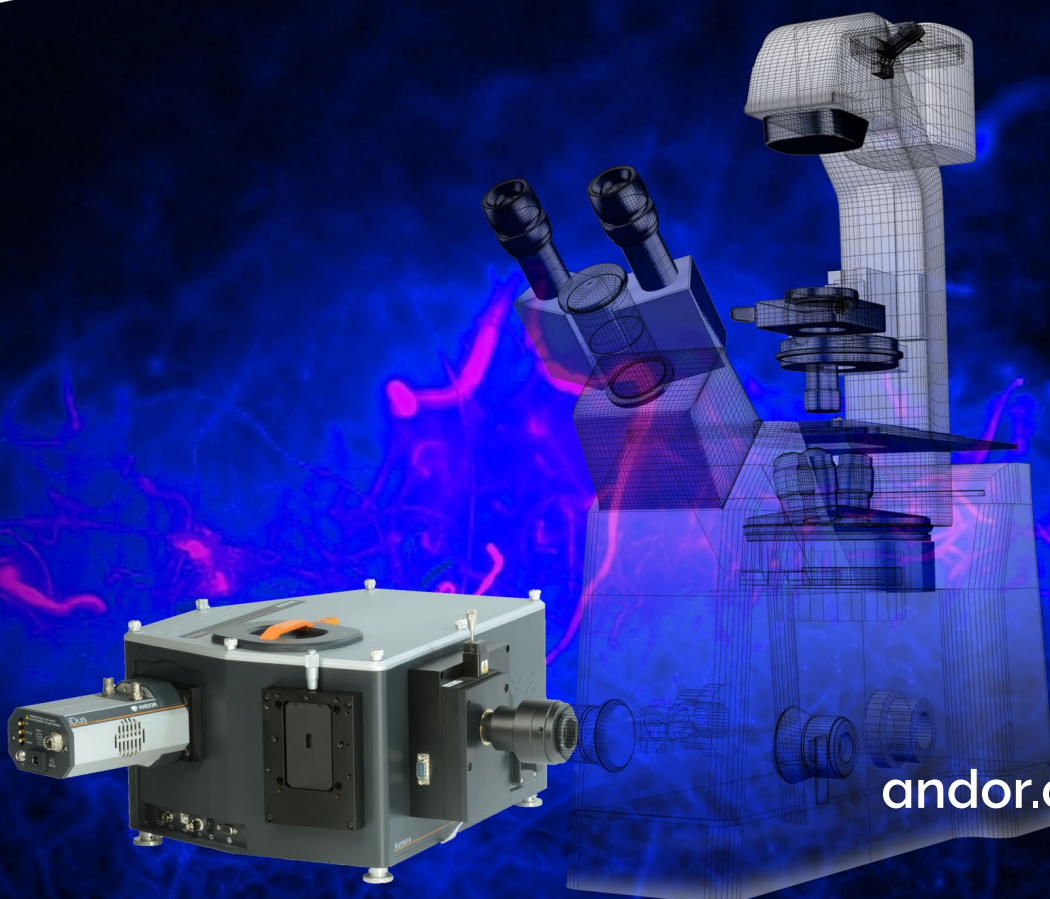

1 Adaptive Focus*



Adaptive Focus:
Automated scan provides optimum focus

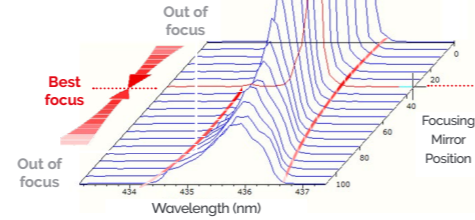

Automated optimization for the best quality of focus:

- Ensures the best resolution at any wavelength
- Automatic optimization when changing between gratings, or cameras
- Software-controlled, easy to switch on and off when required
- No need for tedious adjustment of camera position at the exit ports

*Adaptive Focus Technology, patent WO2016012794 A3

2 TruRes™

True spectral resolution enhancement option

- **Better than 30% spectral resolution improvement** without the need to change grating or slit width
- Expands the range of spectral resolutions accessible on a single setup at the touch of a button
- Superior discrimination of complex spectral features from UV to SWIR
- No mathematical spectral deconvolution required

3 Quad Turret with RFID



Expand your system's flexibility

Combine up to 4 gratings for greater flexibility in one single setup:

- Spectral resolution: Choice of high, medium or low options
- Blaze: Choice of UV, Visible, NIR or SWIR options
- Mirror for microspectroscopy



eXpressID™: RFID -based intelligence ensures automatic recognition and upload of all important turret parameters to the spectrograph.

TruRes™: Delivers enhanced spectral resolution

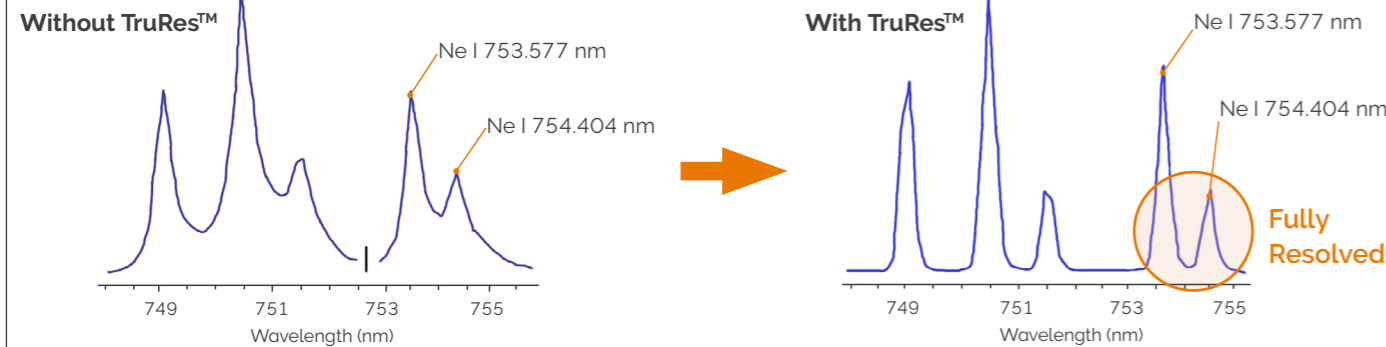

Kymera 328i with 300 l/mm grating, iVac 316 with high resolution 15 μm pixels, full vertical binning.

4 Dual Input and Output Options



Convenient interfacing to complex experiments with multiple light paths, greatly minimizes switching time between setups.

Dual port setups include various combinations of:

- CCD cameras for UV, Vis and NIR spectroscopy
- ICCD cameras for time-resolved measurements from UV to NIR
- Exit slits for monochromator tuneable light source
- Fibre coupling at exit port to deliver output light/signal to another part of experiment



Features and Benefits

| Feature | Benefit |
|---|---|
| 328 mm focal length, F/4.1 aperture | Ideal combination for a wide range of applications ranging from luminescence/ photoluminescence spectroscopy to more demanding, higher resolution Raman spectroscopy or plasma studies. |
| Adaptive Focus (patented) | Intelligent and user-friendly interface for uncompromised spectral resolution performance. |
| TruRes™ | Intuitive, rapid and fully user-controlled option for greater than 30% true spectral resolution enhancement at the touch of a button. Enhance the discrimination power of your spectrograph without tedious grating or grating turret change. |
| Quad-grating turret with eXpressID™ RFID technology | Seamless field-upgradability with precise indexing interface and user-friendly hatch access. Automatic gratings recognition with embedded RFID tags - minimum user interaction. Maximum resolution and band-pass flexibility. |
| Astigmatism-corrected optical design | Toroidal optics enable multi-track fiber detection and excellent sample image relay from a microscope at the grating 'O' order. |
| Robust on-axis wavelength drive | High accuracy direct-drive delivers superb single-grating and grating-to-grating center wavelength repeatability down to 4 and 10 pm respectively. |
| Dual outputs | Extended wavelength coverage when combining Andor UV-NIR CCD, EMCCD, ICCD and InGaAs cameras. Slit option for monochromator operation. |
| Dual input ports | Great setup flexibility for complex, multi-samples or multi-light path experiments based on spectroscopy modalities combining for example Raman, Fluorescence, Optical Emission Spectroscopy (OES), Absorption or Second Harmonic Generation (SHG). |
| USB interface | Plug-and-play connectivity, ideal for laptop operation alongside Andor USB cameras. |
| Seamless connection to microscopes | Adjustable height feet and choice of direct, lens relay, or cage system-based interfaces. 15 mm wide-aperture input slit for extended sample image relay and spectral analysis through the same optical path. |
| Protected silver-coated optics option | Most efficient for NIR/SWIR detection when used in conjunction with Andor InGaAs cameras. |
| Pre-aligned, pre-calibrated instrument | Individually characterized spectrograph-detector systems for out-of-the box operation. |
| High repetition rate shutter | 10 Hz continuous operation and 40 Hz burst mode for ultrafast acquisition. |
| μ-Manager software integration | Simultaneous control of Andor cameras, spectrographs and a wide range of microscopes and accessories through 1 single software platform. Dedicated, user-friendly spectrum handling interface. |
| Integrated in EPICS •20 | Integration and operation at EPICS-based large research facilities. |

μ-Manager and Microspectroscopy

User-friendly simultaneous access to Andor Kymera spectrographs, low-light spectroscopy cameras and a wide range of microscopes and microscope accessories.

Andor's dedicated interface allows seamless spectral acquisition, display and manipulation, as well as facilitating 'spectral' mapping sequences with advanced metadata handling.

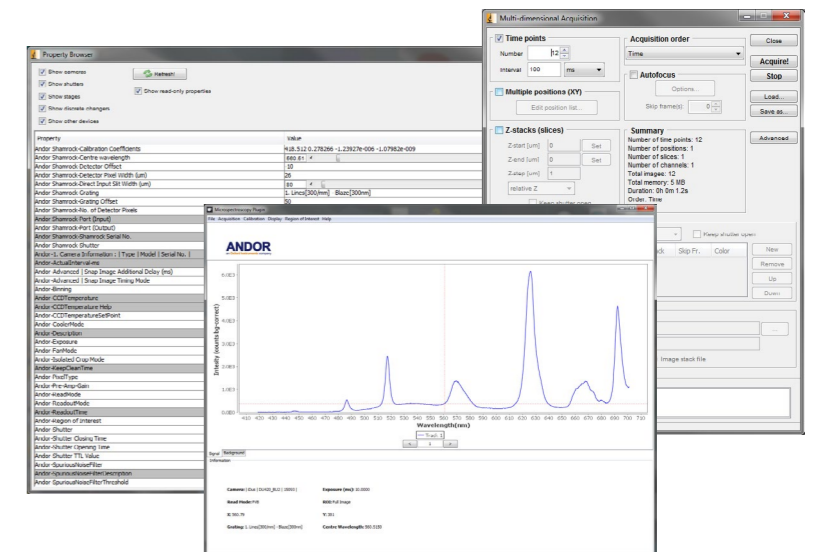

Step-by-Step System Configuration

How to customise the Kymera 328i:

- Resolution Boost
- Quad Turret
- On-axis Rotation
- Auto Focus
- Detector 1
- Detector 2

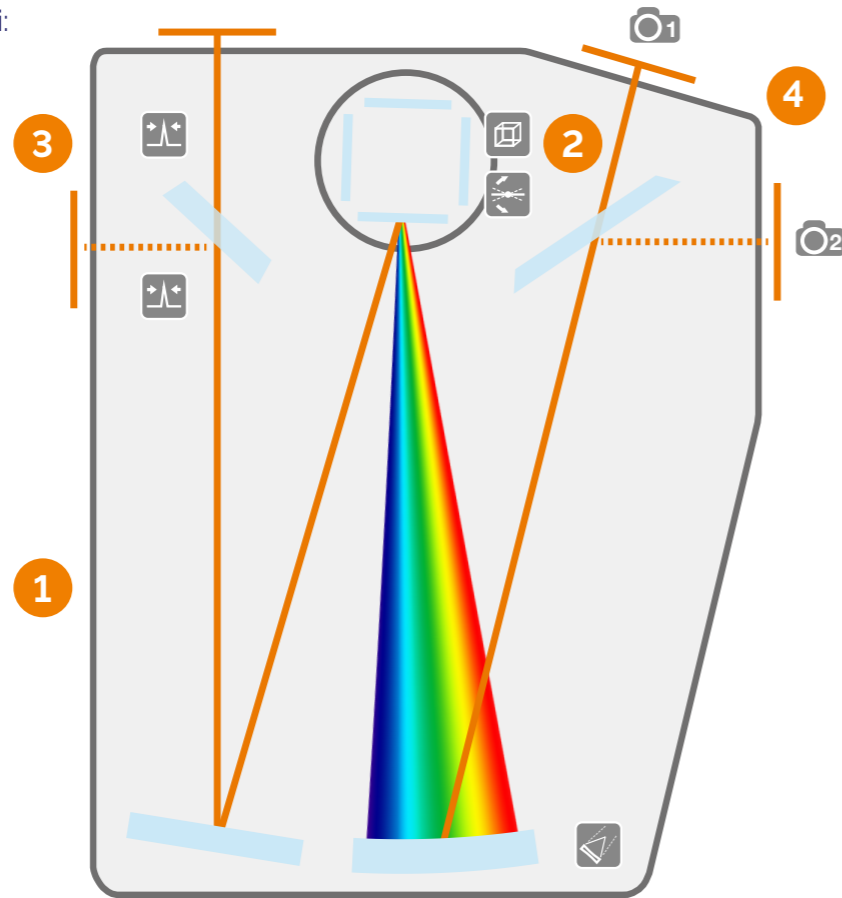

1 Chassis configuration

- a) Select combination of input and output ports (see page 5 for available options).
- b) Select type of optics coating required (aluminium + MgF₂ is standard, protected silver-coated optics available on request for NIR detection).
- c) Select purge port option (for improved detection down to 180 nm). Shutter for background acquisition and protection of the detector.

2 Resolution & band-pass

Select gratings and detector to fulfil resolution and wavelength requirements.

3 Input light coupling interface

Refer to accessory tree for available configurations (direct coupling, fibre coupling or 3rd party hardware connectivity).

4 2nd exit port configuration

Refer to accessory tree for available configurations, including camera flanges.

5 Software interface

Select either state-of-the-art Solis software or Software Development Kit (SDK) option – please refer to the appropriate section for further information.

Step 1 - Chassis Configuration

Ordering Information

| Model | Side input port | Direct input port | Direct output port | Side output port | Motorized port selection |
|-------------------|--|-------------------|--------------------|------------------|--------------------------|
| KYMER-328i-A | Manual slit | - | Camera | - | - |
| KYMER-328i-B1 | Manual slit | - | Camera | Manual slit | ✓ |
| KYMER-328i-B2 | Manual slit | - | Camera | Camera | ✓ |
| KYMER-328i-C | Manual slit | Manual slit | Camera | - | ✓ |
| KYMER-328i-D1 | Manual slit | Manual slit | Camera | Manual slit | ✓ |
| KYMER-328i-D2 | Manual slit | Manual slit | Camera | Camera | ✓ |
| KYMER-328i-xx-SIL | Protected silver-coated optics options for models shown above (replace x with relevant model number) | | | | |

Optical Coatings Reflectivity Graph

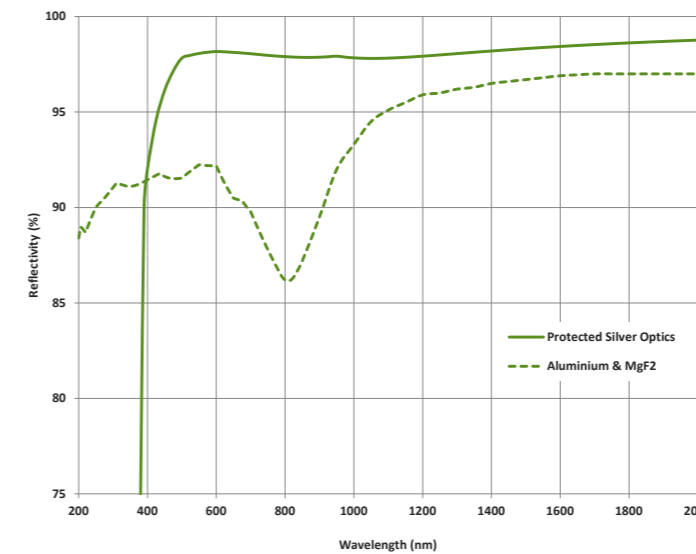

Standard systems use Al + MgF₂ coated optics. Protected silver optics are also available on request for maximum efficiency in the NIR region - recommended for working with Andor iDus InGaAs detectors or IR single-point detectors, such as MCT, PbS and InSb.

When choosing protected silver coatings, it is strongly recommended to also order **protected silver-coated gratings** for maximum efficiency throughout the system.

Chassis Accessories

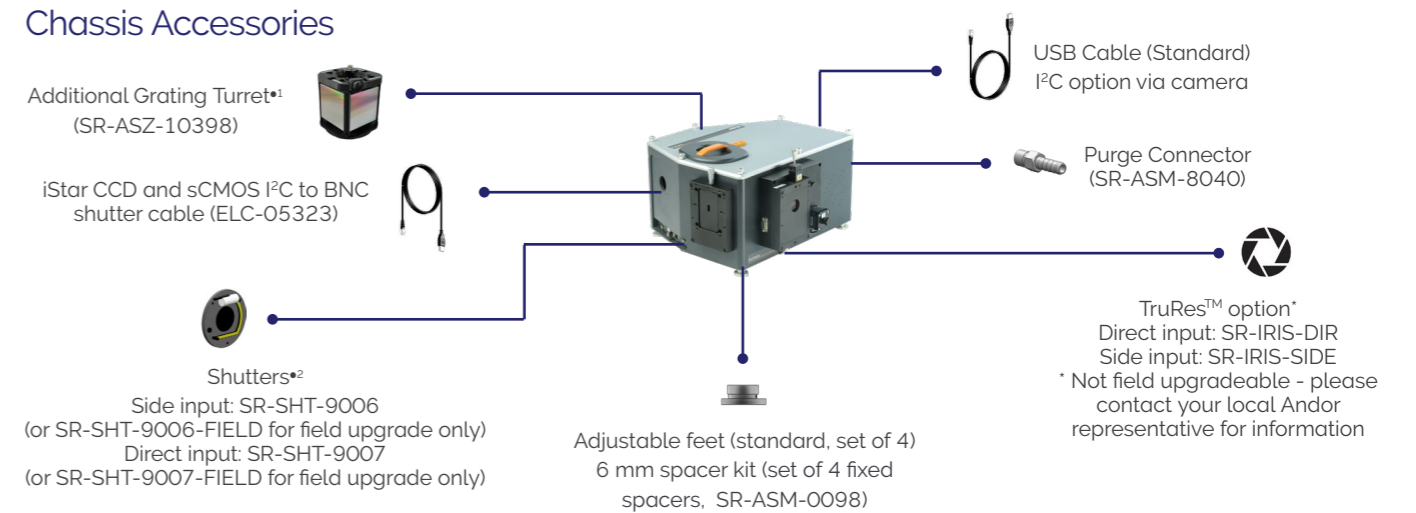

| Nominal optical height | Optical height adjustment range | Adjustable feet set |
|------------------------|----------------------------------|------------------------------|
| 142.6 mm | 142.6 – 148.6 mm (standard feet) | SR-ASM-0098: 6 mm spacer set |

Step 2a - Choosing The Right Platform vs Dispersion Requirements

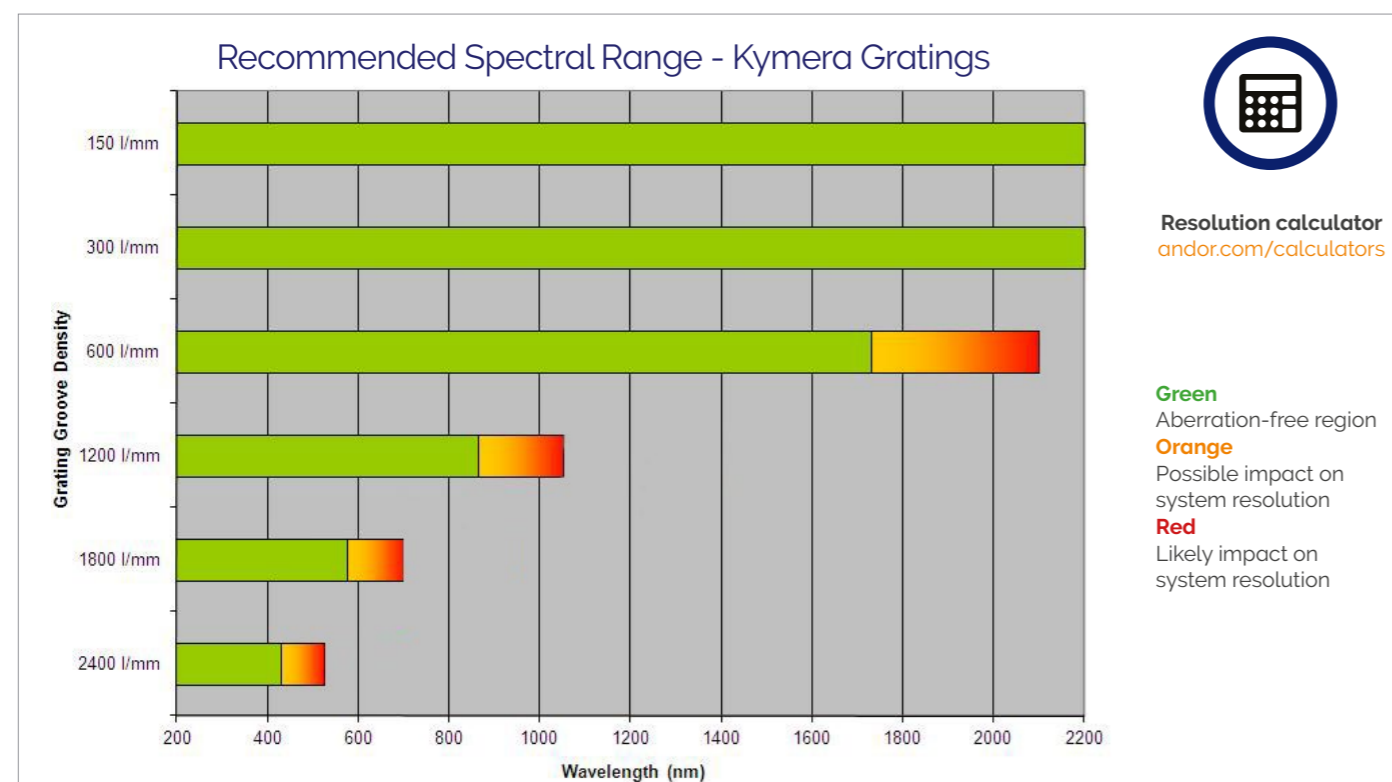

Czerny-Turner spectrographs are designed to provide the best optical performance for a range of grating angles as reflected on the green parts of the graph above. Outside this range, the spectral lines may exhibit a degree of optical aberration (such as coma), which will become more prominent at the steeper angles. These configurations are reflected by the orange to red scales on the graph. In these regions, consideration should be given to higher spectrograph focal length models with lower groove density gratings to achieve the desired resolution.

| | Grating (l/mm) | | | | | |
|--|----------------|-----|-----|------|-------------|-------------|
| | 150 | 300 | 600 | 1200 | 1800 (Holo) | 2400 (Holo) |

Kymera 193i

| | | | | | | |
|--------------------------------|------|------|------|------|------|-------------------|
| Bandpass (nm) ^{3,5} | 902 | 445 | 215 | 98 | 56 | 46 ⁶ |
| Resolution (nm) ^{4,5} | 1.96 | 0.96 | 0.47 | 0.21 | 0.12 | 0.10 ⁶ |

Kymera 328i

| | | | | | | |
|--------------------------------|-----------|-----------|-----------|-----------|-----------|------------------------|
| Bandpass (nm) ^{3,5} | 542 | 268 | 131 | 61 | 41 | 29 ⁶ |
| Resolution (nm) ^{4,5} | 0.88→0.62 | 0.44→0.31 | 0.21→0.15 | 0.10→0.07 | 0.06→0.04 | 0.05→0.04 ⁶ |

Shamrock 500i

| | | | | | | |
|--------------------------------|------|------|------|------|------|-------------------|
| Bandpass (nm) ^{3,5} | 357 | 177 | 86 | 40 | 26 | 19 ⁶ |
| Resolution (nm) ^{4,5} | 0.52 | 0.26 | 0.13 | 0.06 | 0.04 | 0.03 ⁶ |

Shamrock 750

| | | | | | | |
|--------------------------------|------|------|------|------|------|-------------------|
| Bandpass (nm) ^{3,5} | 242 | 120 | 59 | 28 | 18 | 14 ⁶ |
| Resolution (nm) ^{4,5} | 0.35 | 0.18 | 0.09 | 0.04 | 0.03 | 0.02 ⁶ |

Where aberration is a concern for a particular experimental set-up, the table above shows resolution and band-pass performance for a variety of alternative configurations. This should be used in conjunction with the graph above to assist in selecting the most appropriate spectrograph platform to meet resolution and band-pass needs, whilst minimising the risk of potential aberration.

Step 2b - Choosing The Right Grating vs Resolution and Band-pass

The Kymera 328i features an on-axis, quadruple grating turret, designed to offer flexibility and control over your choice and interchange of gratings. The 'Quad' grating turret can be easily and speedily removed, and replaced by an alternative turret with new gratings. The intelligent design of the 328i with xPressID™ RFID technology, means that only a simple offset adjustment is required once the new turret and gratings are added. The 328i is shipped with the grating turret already in place, ensuring your system is ready for use straight out of the box. Additional grating turrets are available with up to four pre-installed gratings (see below for details). If the grating you require is not on the list, please contact Andor for further details. Additional grating turrets (part number SR-ASZ-10398) can also be supplied on request.



| Lines/mm | Blaze (nm) | Nominal dispersion (nm/mm) ⁷ | Bandpass (nm) ^{3,6,7} | Resolution (nm) ^{4,7,8,10} | Peak efficiency (%) | Andor part number | Maximum recommended wavelength [nm] ⁹ |
|----------|---------------------------|---|--------------------------------|-------------------------------------|---------------------|-----------------------------|--|
| 150 | 300 | 19.70 | 545 | 0.89→0.62 | 72 | SR-GRT-0150-0300 | 6820 |
| 150 | 500 | 19.60 | 542 | 0.88→0.62 | 73 | SR-GRT-0150-0500 | |
| 150 | 800 | 19.50 | 539 | 0.88→0.62 | 80 | SR-GRT-0150-0800 | |
| 150 | 1250 | 19.30 | 534 | 0.87→0.61 | 84 | SR-GRT-0150-1250 | |
| 150 | 2000 | 18.90 | 523 | 0.85→0.60 | 88 | SR-GRT-0150-2000 | 3410 |
| 300 | 300 | 9.80 | 271 | 0.44→0.31 | 88 | SR-GRT-0300-0300 | |
| 300 | 500 | 9.71 | 268 | 0.44→0.31 | 81 | SR-GRT-0300-0500 | |
| 300 | 1000 | 9.46 | 262 | 0.43→0.30 | 72 | SR-GRT-0300-1000 | |
| 300 | 1200 | 9.34 | 258 | 0.42→0.29 | 92 | SR-GRT-0300-1200 | 1705 |
| 300 | 1700 | 9.00 | 249 | 0.41→0.29 | 89 | SR-GRT-0300-1700 | |
| 600 | 300 | 4.83 | 134 | 0.22→0.15 | 84 | SR-GRT-0600-0300 | |
| 600 | 500 | 4.73 | 131 | 0.21→0.15 | 72 | SR-GRT-0600-0500 | |
| 600 | 1000 | 4.38 | 121 | 0.20→0.14 | 72 | SR-GRT-0600-1000 | 850 |
| 600 | 1200 | 4.20 | 116 | 0.19→0.13 | 88 | SR-GRT-0600-1200 | |
| 600 | 1900 | 3.39 | 94 | 0.15→0.11 ⁹ | 88 | SR-GRT-0600-1900 | 1230 |
| | (@1600) ⁸ | 3.78 | 105 | 0.17→0.12 | 88 | SR-GRT-0600-1900 | |
| 830 | 820 | 3.08 | 85 | 0.14→0.10 | 87 | SR-GRT-0830-0820 | 570 |
| 830 | 1200 | 2.68 | 74 | 0.12→0.08 | 83 | SR-GRT-0830-1200 | |
| 1200 | 300 | 2.33 | 64 | 0.10→0.07 | 72 | SR-GRT-1200-0300 | 425 |
| 1200 | 500 | 2.19 | 61 | 0.10→0.07 | 81 | SR-GRT-1200-0500 | |
| 1200 | 1000 | 1.62 | 45 | 0.07→0.05 ⁹ | 69 | SR-GRT-1200-1000 | |
| 1200 | Holographic (500 nm peak) | 2.19 | 61 | 0.10→0.07 | 81 | SR-GRT-1200-EH ¹ | |
| 1800 | Holographic (250 nm peak) | 1.30 | 36 | 0.06→0.04 | 70 | SR-GRT-1800-DH | 570 |
| 1800 | Holographic (380 nm peak) | 1.52 | 42 | 0.07→0.05 | 62 | SR-GRT-1800-FH | |
| 2400 | 300 | 1.05 | 29 | 0.05→0.04 | 68 | SR-GRT-2400-0300 | 425 |
| 2400 | Holographic (220 nm peak) | 1.12 | 31 | 0.05→0.04 | 68 | SR-GRT-2400-BH | |
| 2400 | Holographic (400 nm peak) | 0.95 | 26 | 0.04→0.03 | 73 | SR-GRT-2400-GH | |
| Mirror | UV-VIS | - | - | - | - | SR-GRT-MR-AL-MGF2 | - |
| Mirror | VIS-NIR | - | - | - | - | SR-GRT-MR-SILVER | - |

¹Option for minimized scattered light.

Step 2c - Selecting The Correct Grating Efficiency Option

All graphs shown below represent efficiency for 45° polarisation

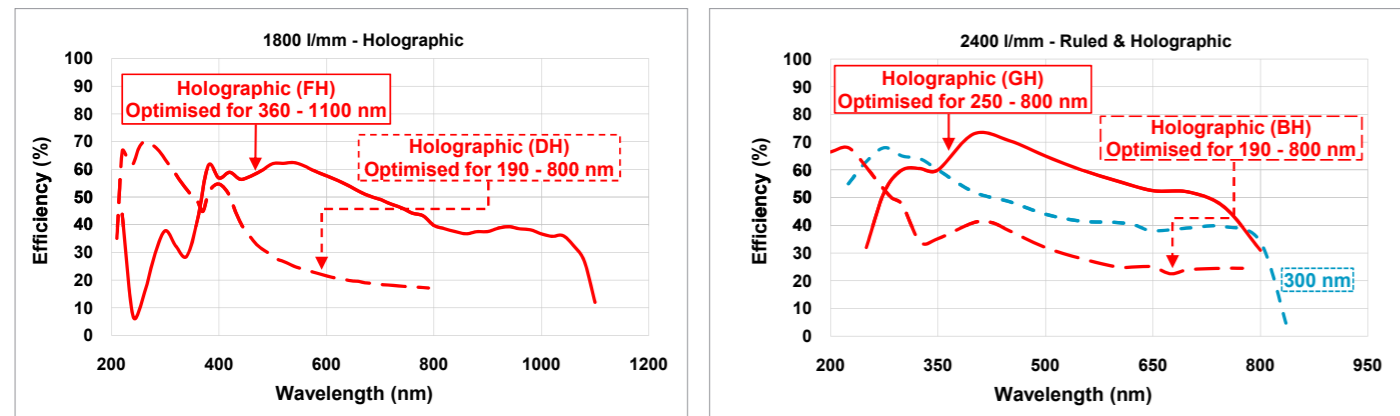
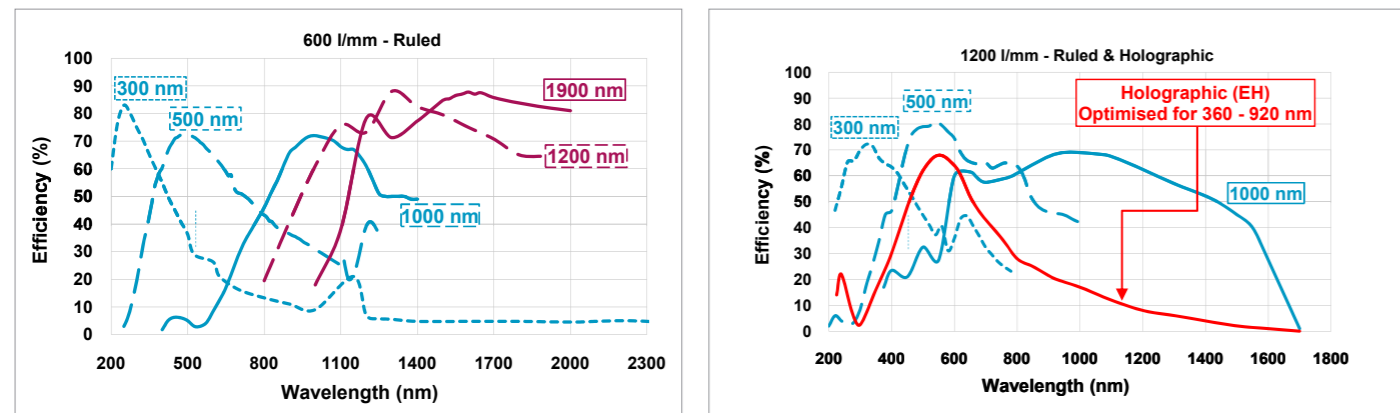
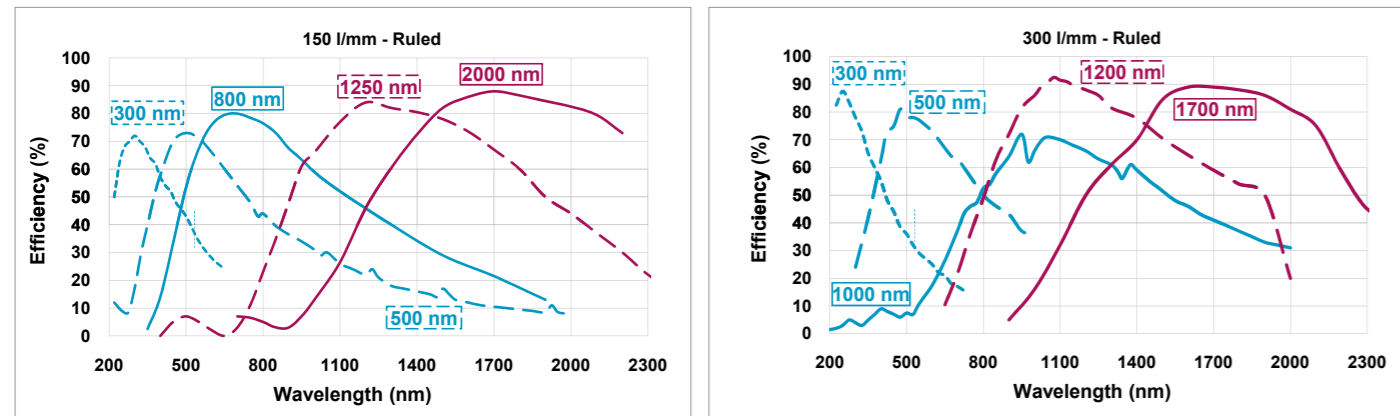

Important Consideration

System throughput is dependent on the grating's angle of operation and may decrease with higher grating operating angles.

Need to have maximum collection efficiency in the NIR/SWIR? All gratings are also available with protected silver coating. Please contact your local representative for further information.

Step 3 - Selecting The Correct Light Coupling Interfaces

How to customize the Kymera 328i (Side Entrance Port):

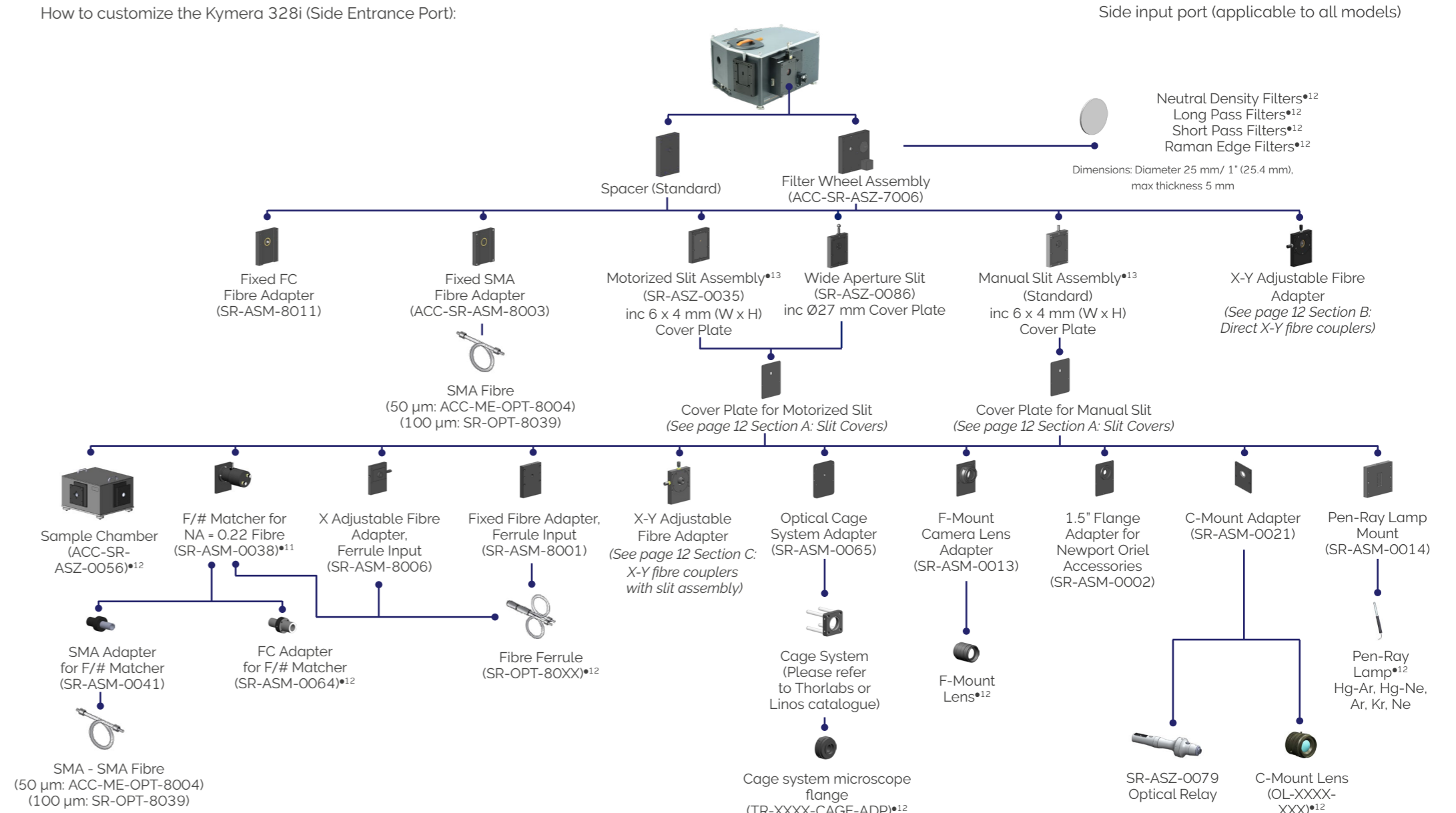

Step 3 - Selecting The Correct Light Coupling Interfaces

How to customize the Kymera 328i (Direct Entrance Port):

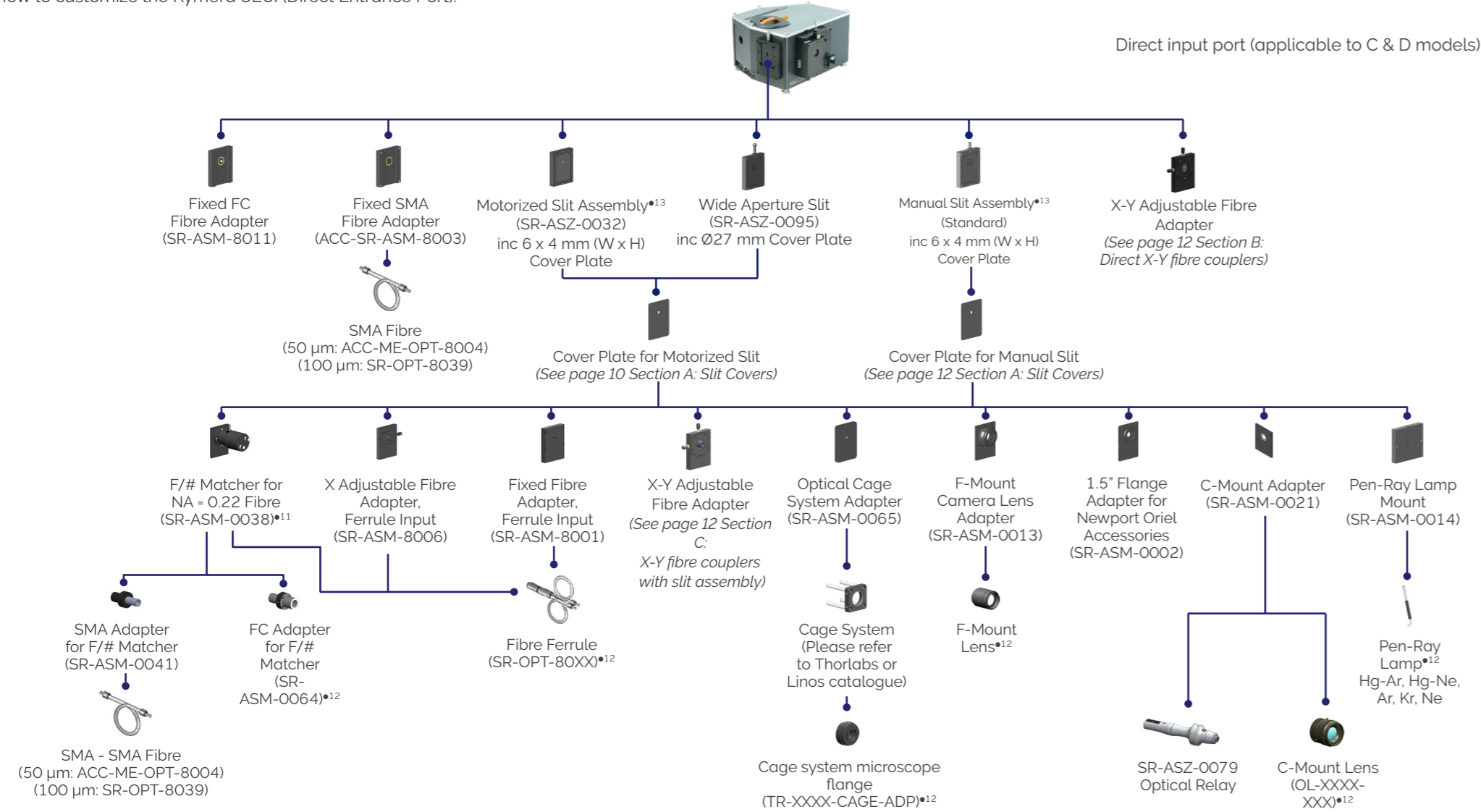

Step 4 - Cameras and Output Port Flanges

How to customize the Kymera 328i:

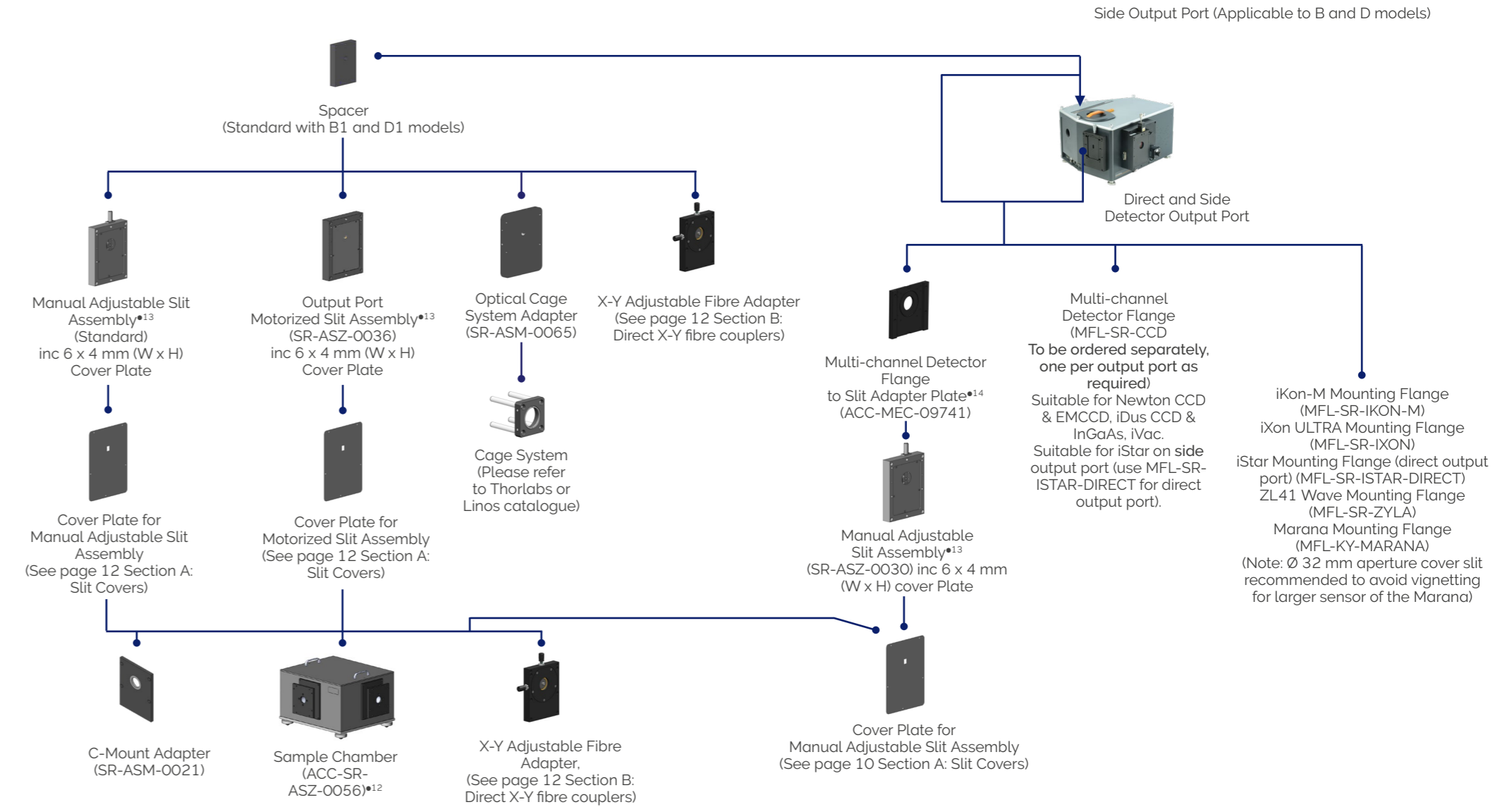

Note: a flange MUST be ordered separately for any configuration involving a multichannel or InGaAs detector.

Step 4A: Slit Covers

| Size | Motorised Slit | Manual Slit |
|--------------------|----------------------------|----------------------------|
| 6 x 4 mm (W x H) | SR-ASM-0016 ^{•14} | SR-ASM-0025 |
| 6 x 6 mm (W x H) | SR-ASM-0017 | SR-ASM-0026 |
| 6 x 8 mm (W x H) | SR-ASM-0010 | SR-ASM-0027 |
| 6 x 14 mm (W x H) | SR-ASM-0011 | SR-ASM-0029 ^{•14} |
| Ø 27 mm | SR-ASM-0072 ^{•15} | SR-ASM-0100 ^{•15} |
| (Ø 32 mm aperture) | SR-ASM-0107 | SR-ASM-0106 |

Step 4B - X-Y Fibre Coupler (with NO slit)

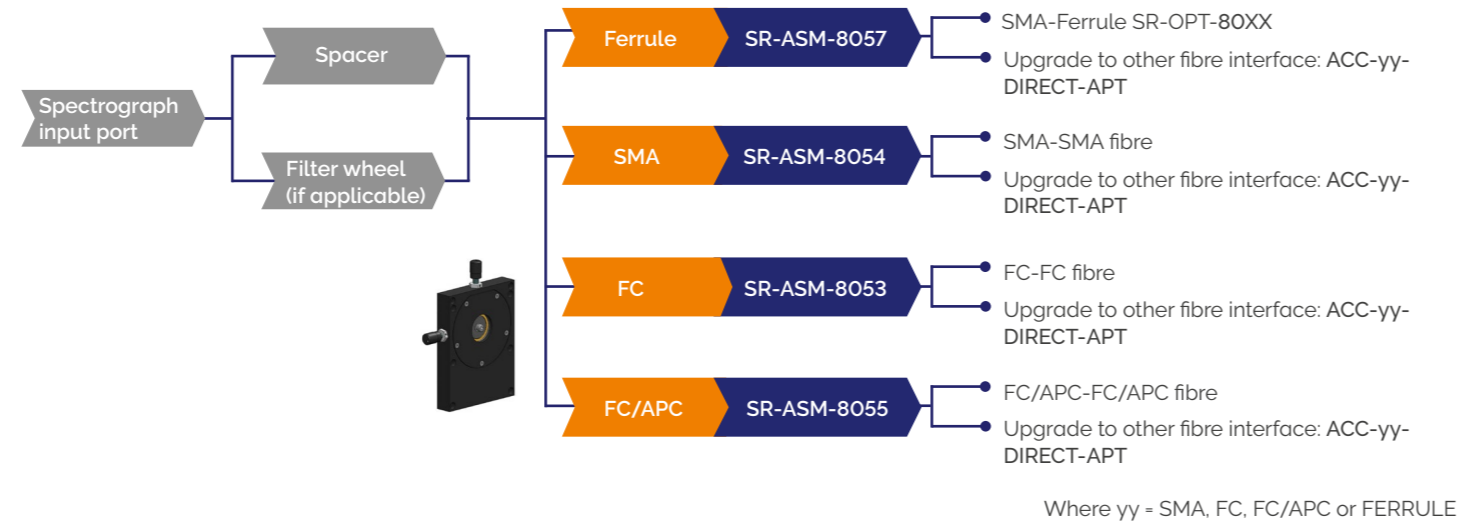

Step 4C - X-Y Fibre Coupler (with slit assembly)



- Notes:
- For connection to manual slits, please also order Ø27 mm slit cover plate SR-ASM-0100
 - For connection to motorized slits, please also order Ø27 mm slit cover plate SR-ASM-0072
 - For connection to manual slits, please also order Ø32 mm slit cover plate SR-ASM-0106 (Marana sCMOS)
 - For connection to motorized slits, please also order Ø32 mm slit cover plate SR-ASM-0107 (Marana sCMOS)

Step 5 - Selecting A Software Option

The Kymera 328i requires at least one of the following software options:

- 1 - **Solis Spectroscopy** A 32-bit and fully 64-bit enabled application for Windows (8, 8.1 and 10) offering rich functionality for data acquisition and processing, as well as Andor cameras, spectrograph and motorized accessories simultaneous control. AndorBasic provides macro language control of data acquisition, processing, display and export.
- 2 - **Standalone Solis Spectroscopy** GUI for standalone spectrograph operation.
- 3 - **Kymera and Shamrock SDK** A software development kit that allows you to control the Andor range of Kymera and Shamrock spectrographs from your own application. Compatible as 32-bit and 64-bit libraries for Windows (8, 8.1 and 10). Compatible with C/C++, C#, VB.NET and LabVIEW for Windows/Linux.

Solis Spectroscopy: Dedicated spectroscopy acquisition software

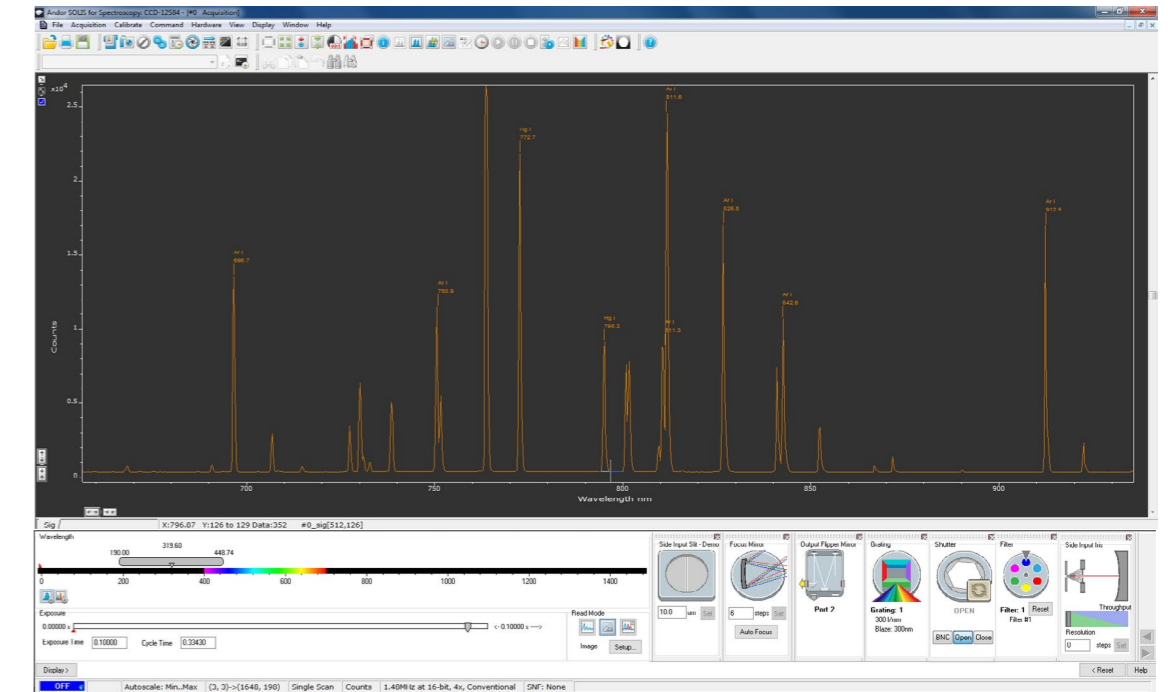

Wavelength selection and step-and-glide

Set the wavelength of interest by dragging slider or typing the desired value. For step-and-glide, select wavelength range for extended bandpass and high resolution acquisition.

Exposure time

Set the exposure time for the detector - quick access for easy acquisition optimization.

Real Time Control

- (a) Slit drive: Control the spectrograph slit width - drag blades on icon or type in required slit width
- (b) Adaptive focus: Used for automatic fine focus optimization
- (c) Turning mirror: Used to select the appropriate exit port
- (d) Grating turret: Used for setting grating turret to a new position and bringing desired grating in the optical path - just click on the desired grating
- (e) Shutter: Synchronization mode selection for shutter operation
- (f) Filter wheel: Used to select a particular filter on the filter wheel - just click on the desired filter position
- (g) TruRes™: Used for spectral resolution enhancement - simply type in the setting that is best suited to the resolution target.

Product Dimensions

Dimensions in mm (inches)

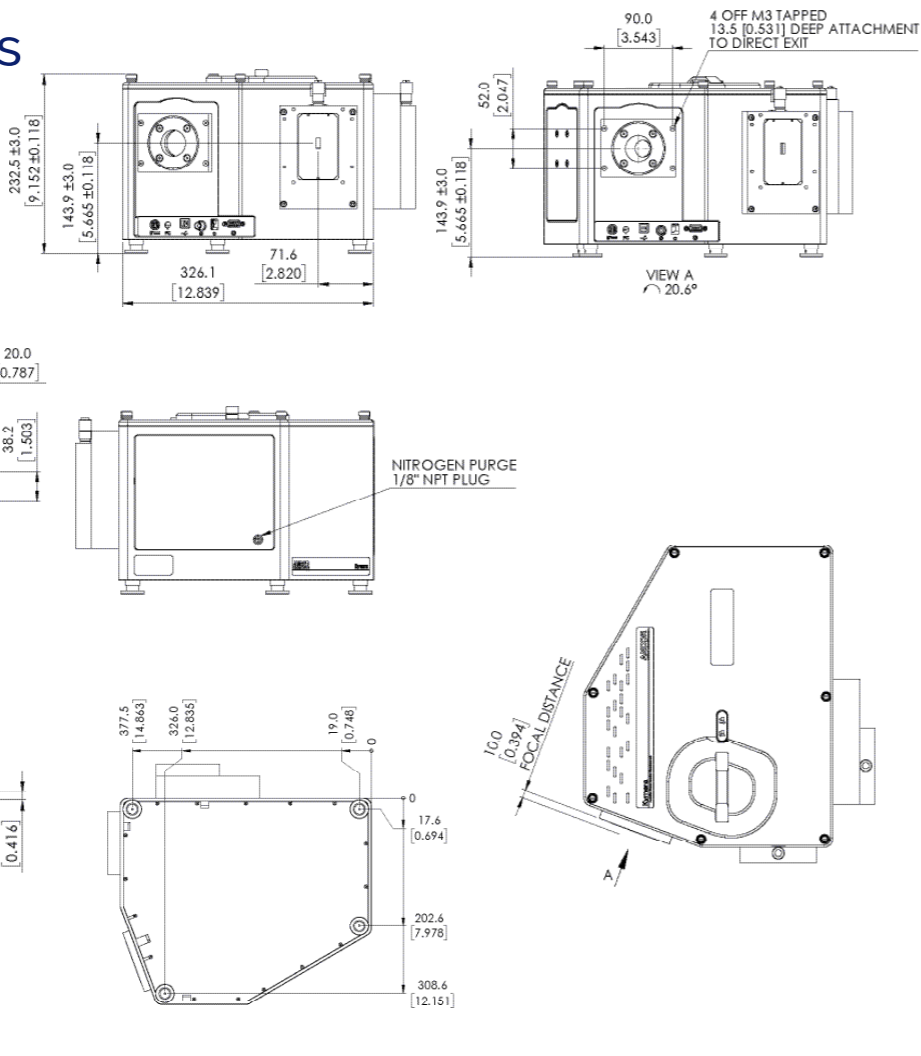

Shutter Specifications

| | |
|-------------------------|----------------------------------|
| Maximum repetition rate | 40 Hz - burst; 10 Hz - sustained |
| Minimum open/close time | 6 ms |
| Minimum lifetime | 1 Million cycles |

Optical Property

| | |
|------------------------------|----------------------|
| Focal plane size (mm, W x H) | 30 x 14 |
| Grating size (mm) | 68 x 68 |
| Stray light ^{•16} | |
| 1 nm from laser | 3.8×10^{-4} |
| 10 nm from laser | 4.7×10^{-5} |
| 20 nm from laser | 8.9×10^{-6} |
| Magnification | 1.1:1 |

Wavelength Drive Performance

| | |
|---|---------|
| Wavelength accuracy center ^{•17} | 0.04 nm |
| Wavelength repeatability ^{•18} | |
| Single grating | 4 pm |
| Grating-to-grating | 10 pm |

Wavelength Side Accuracy

| | |
|---|--------|
| Wavelength side accuracy ^{•19} | 0.2 nm |
|---|--------|

Standard configuration shown with manual slit on input, CCD flange on straight output.

Weight: 18 kg | 39.7 lbs| approx

Optical Axis

Standard feet: Nominal optical axis height: 143.9 mm +/- 3.0 mm, increments of 6 mm with stackable spacer kit (SR-ASM-0098).

Connecting to the Kymera 328i

USB Control

Connector type: USB 'B' type

I²C Connector

For connection to camera/detector via I²C connection (replaces USB cable connection to spectrograph).

Shutter Control

Connector type: BNC Female, 50 Ω

Our Cameras for Spectroscopy

Spectroscopy-based diagnostics in the fields of Material Science, Chemistry, Life Science or Fundamental Physics & Optics rely on the capture and analysis of optical and chemical signatures with a high degree of precision.

Andor's range of detectors offer a wide range of sensitivity, time-resolution and sensor formats to best suit specific experimental conditions from UV to SWIR, nanosecond to hours time resolution, high photon flux to single photon with super dynamic range and resolution.

High Sensitivity & Dynamic Range



- ✓ Long exposure
- ✓ High sensitivity UV-SWIR
- ✓ Large pixel well depths
- ✓ High resolution matrix

iDus CCD & InGaAs | Newton CCD & EM

ns to μs Time-Resolution



- ✓ Nanosecond gating
- ✓ High sensitivity down to single photon
- ✓ On-head DDG with ps accuracy

iStar CCD & sCMOS

kHz Spectral Rates

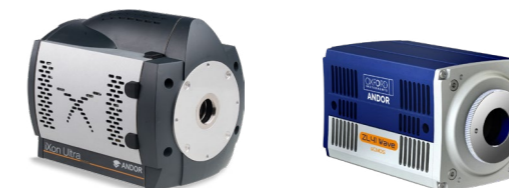

- ✓ μs to ms time-resolution
- ✓ High sensitivity down to single photon
- ✓ High resolution matrix

Newton CCD & EMCCD | iXon EMCCD | ZL41 Wave sCMOS | Marana sCMOS

Extended Multi-fibre Spectroscopy

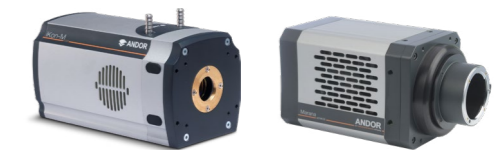

- ✓ Large area sensors
- ✓ Ultrafast sCMOS and EMCCD options
- ✓ High sensitivity down to single photon

iKon-M CCD | iXon EMCCD | ZL41 Wave sCMOS | Marana sCMOS | iStar CCD & sCMOS

Learn more about our detector range [here](#).

Order Today

At Andor we are committed to finding the correct solution for you. With a dedicated team of technical advisors, we are able to offer you one-to-one guidance and technical support on all Andor products.

For a full listing of our local sales offices, please see: andor.oxinst.com/contact

Our regional headquarters are:

Europe

Belfast, Northern Ireland
Phone +44 (28) 9023 7126
Fax +44 (28) 9031 0792

North America

Concord, MA, USA
Phone +1 (860) 290 9211
Fax +1 (860) 290 9566

Japan

Tokyo
Phone +81 (3) 6732 8968
Fax +81 (3) 6732 8939

China

Beijing
Phone +86 (10) 5884 7900
Fax +86 (10) 5884 7901



Footnotes: Specifications are subject to change without notice

- In the case of a multiple grating turret order, please specify desired grating configuration for each turret.
- Shutter operation can be achieved directly through the I2C interface between cameras and spectrograph, or through a BNC-to-SMB cable when the spectrograph is operated through USB.
- Typical values quoted with 27.6 mm wide CCD, e.g. Newton DU940.
- Typical values quoted with 10 μm slit and 13.5 μm pixel CCD, e.g. Newton DU940. Illustrates resolutions achievable with iris opening range (optional).
- Typical values quoted at 500 nm centre wavelength.
- Typical values quoted at 300 nm centre wavelength.
- Typical values quoted at maximum efficiency wavelength or blaze wavelength unless otherwise stated.
- Wavelength within the recommended operating spectral region.
- Indicative values; the working range of these gratings is principally in the region where optical aberrations may alter the system resolution performance quoted.
- Useful signal is assumed to be imaged on the entire height of a 6.9 mm sensor (i.e. Newton DU940) and fully vertically binned.
- Please refer to F/# matcher specification sheet for magnification considerations.
- Please refer to the local sales representative or website for further information on available options and complimentary accessories.
- Slit widths range from 10 μm to 2.5 mm.
- Provided as standard.
- Recommended for use with fibre-optics and C-mount accessories.
- Measured with a 633 nm laser and a 1200 l/mm grating for Full Vertical Binning (FVB) on a 6.9 mm high sensor, and a 1 mm strip vertically centred on the optical axis.
- Average measurements using > 30 calibration lines, covering the recommended grating angle operating range with a 1200 l/mm grating.
- The standard deviation of 20 measurements of a peak's centre-of-mass position: - each measurement is taken after switching back and forth between a given centre wavelength and a lower or higher centre wavelength (single grating) or between two gratings set at the same centre wavelength (grating-to-grating).
- Side accuracy measured using a 27.6 mm wide sensor, reflecting the dispersion calibration and step-and-glue accuracy.
- Only Andor CCD platforms (e.g. Newton, iDus, iKon) can be controlled in conjunction with Kymera and Shamrock spectrographs in EPICS software.

Operating and Storage Conditions

- Operating Temperature: stable ambient between 0°C to 30°C
- Relative Humidity: < 70% (non-condensing)
- Storage Temperature: -25°C to 50°C

Power Requirements

- 100 - 240 VAC 50 - 60 Hz
- Max. power consumption: 21 W (10 Hz shutter and grating turret operation)

Items shipped with your spectrograph:

- 1x 3 m USB 2.0 cable Type A to Type B
- 1x Power supply (+24V, 5A) with 3 m mains cable
- 1x I²C to I²C cable
- 1x Andor user guides in electronic format
- 1x Individual system performance booklet
- 1x Solis software or SDK in electronic format (if requested at time of order)
- 1x hex key set (2 mm, 3 mm and 5 mm)

Regulatory Compliance

Compliant with the requirements of the EU EMC and LVD Directives, compliant with the international EMC and safety standards IEC 61326-1 and IEC 61010-1, and Machinery Directive 2006/42/EC.

Minimum Computer Requirements:

- 3.0 GHz single core or 2.4 GHz multi core processor
- 2 GB RAM
- 250 MB free hard disc to install software (at least 1 GB recommended for data spooling)
- USB 2.0 High Speed Host Controller capable of sustained rate of 40 MB/s
- Windows (8.1 and 10)



µManager



Windows is a registered trademark of Microsoft Corporation.
LabVIEW is a registered trademark of National Instruments.
MATLAB is a registered trademark of The MathWorks Inc.